

PosiTector® 6000 Series

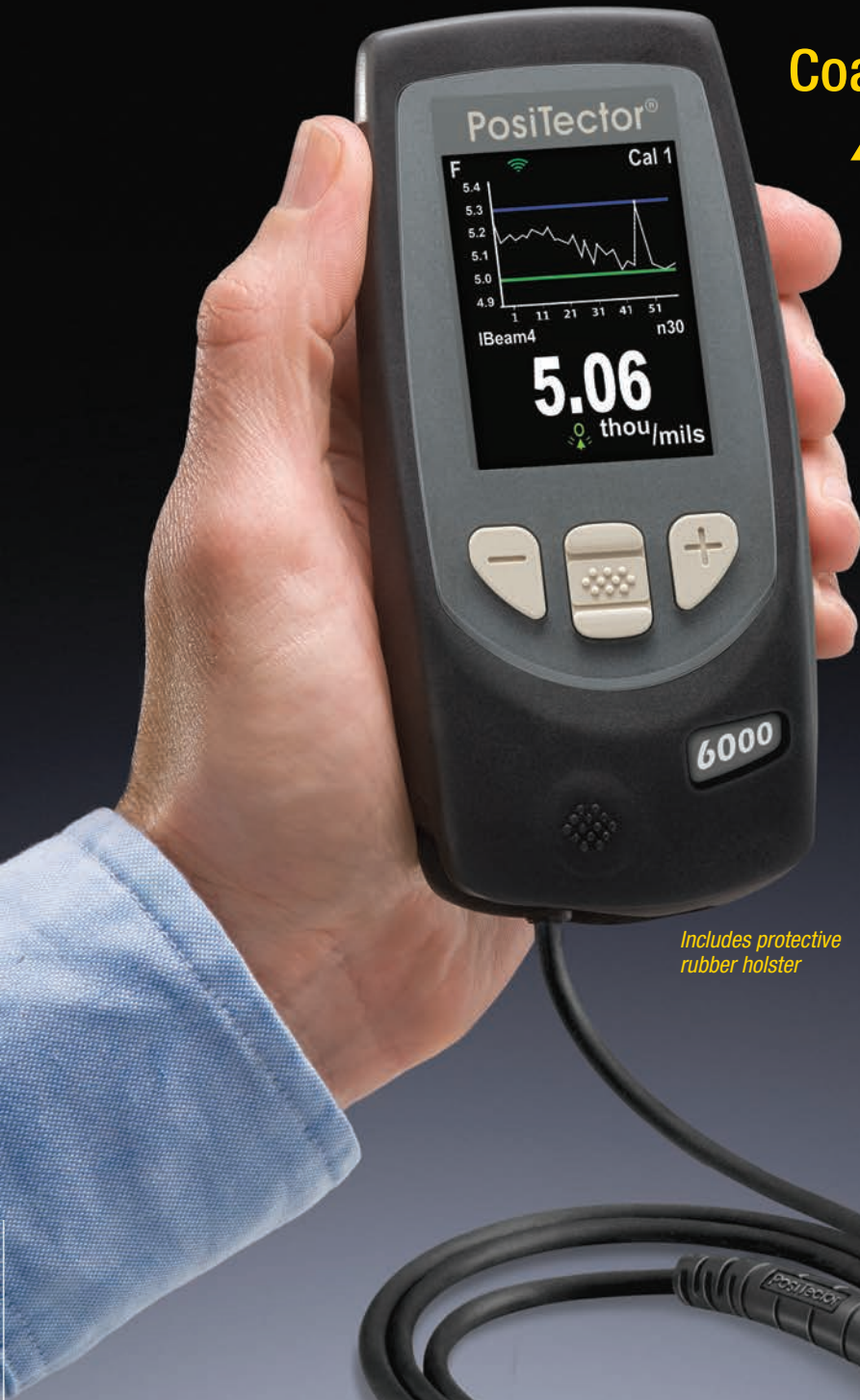

Coating Thickness Gages for **ALL** Metal Substrates



Includes protective rubber holster



DeFelsko®
The Measure of Quality



Available on the
App Store



PosiTector®
SmartLink
Compatible



PosiTector® 6000 Series

All Gages Feature...

Simple

- **NEW** Faster measurement speed—60+ readings per minute
- Ready to measure—no adjustment required for most applications
- Enhanced one-handed menu navigation
- Flashing display—ideal in a noisy environment
- RESET feature instantly restores factory settings

Durable

- Solvent, acid, oil, water and dust resistant—weatherproof
- Wear-resistant probe tip
- Shock-absorbing, protective rubber holster with belt clip
- Two year warranty on gage body AND probe

Accurate

- Certificate of Calibration showing traceability to NIST or PTB included
- Built-in temperature compensation ensures measurement accuracy
- Hi-RES mode increases displayed resolution for use on applications that require greater precision
- Conforms to national and international standards including ISO and ASTM

Versatile

- PosiTector body accepts all PosiTector 6000, 200, DPM, RTR, SPG, SST, SHD, BHI and UTG probes easily converting from a coating thickness gage to a dew point meter, surface profile gage, soluble salt tester, hardness tester or ultrasonic wall thickness gage
- Multiple calibration adjustment options including 1 point, 2 point, known thickness, average zero
- Selectable display languages
- High contrast LCD with backlit display
- Flip Display enables right-side-up viewing
- Extended cables available (up to 75 m/250 ft) for remote measuring
- Uses alkaline or rechargeable batteries (built-in charger)

Powerful

- Continually displays/updates average, standard deviation, min/max thickness and number of readings while measuring
- Screen Capture—save screen images for record keeping and review
- HiLo alarm audibly and visibly alerts when measurements exceed user-specified limits
- **NEW** Enhanced FAST mode—90+ readings per minute for quick inspection
- Sealed USB port for fast, simple connection to a PC and to supply continuous power. USB cable included.
- PosiSoft USB Drive—stored readings and graphs can be accessed using universal PC/Mac web browsers or file explorers. No software required.
- Every stored measurement is date and time stamped
- Includes PosiSoft suite of software for viewing and reporting data (see right panel)

Probes available for a variety of applications



For measuring paint, powder, etc. on all metals...



...and for measuring galvanizing, plating, anodizing and more.

Standard Models

Includes ALL features as shown on left plus...

- Storage of 250 readings per probe—stored readings can be viewed or downloaded

Advanced Models

Includes ALL features as shown on left plus...

- Storage of 100,000 readings from multiple probes in up to 1,000 batches and sub-batches
- Live graphing of measurement data
- 3 Scan Modes — increase measurement speed to 180+ readings per minute
 - **Normal** – take continuous readings without lifting the probe
 - **NEW Statistics** – take continuous readings and record average, standard deviation, min/max thickness and number of readings while scanning
 - **NEW Limited Count Average** – take continuous readings up to a user-specified count. The gage displays and records the average of the readings.
- Multiple stored calibration adjustments for measuring on a variety of substrate conditions
- SSPC-PA 2 feature determines if film thickness over a large area conforms to user-specified min/max levels
- PSPC 90/10 feature determines if a coating system complies with an IMO performance standard for protective coatings
- WiFi technology wirelessly synchronizes with PosiSoft.net and downloads software updates
- **Bluetooth 4.0 Technology** for data transfer to a mobile device running the PosiTector App or optional portable printer. **BLE API** available for integration into third-party software.
- Onscreen Batch Annotation—add notes, change batch names and more with built-in QWERTY keyboard

PosiTector SmartLink™

- Wirelessly connect PosiTector 6000 probes to your smart device

Select from a variety of measurement ranges and probe styles

(see back page ordering guide)



Cabled Probe Style



Integral Probe Style



Thick

90°

0°

45°

Regular

Rugged Features...

Sealed USB Port for communicating with a PC or Mac

Water and dust resistant



High contrast color LCD with backlit display

Scratch/solvent/impact resistant lens

Multi-function navigation button

Solvent, acid, oil resistant, high grade, industrial strength housing

Advanced Model shown in Memory Mode

Quality high-flex cable and strain relief

Stainless steel probe with knurled finger grip

Strong wear-resistant ruby-tipped probe



All Regular Cabled Probes are suitable for underwater use

PosiSoft... FREE SOLUTIONS for viewing, analyzing and reporting data:



PosiSoft Desktop

Powerful desktop software for downloading, viewing, printing and storing measurement data. Includes customizable, templated PDF Report Generator. No internet connection required.

NEW Prompted Batch Mode

Create pre-defined batches with onscreen text and image prompts for each reading and upload to PosiTector 6000 Advanced models only. Ideal for ensuring a consistent measurement pattern for repetitive jobs.

PosiSoft.net

A web-based application offering secure centralized management of readings. Includes customizable, templated PDF Report Generator. Access your data from any web-connected device.



PosiTector App

Mobile app connects PosiTector Advanced instruments, the PosiTector SmartLink and the PosiTest AT-A to your iOS or Android smart device.



PosiSoft USB Drive

A simple gage interface to retrieve data in a manner similar to USB flash drives, cameras, or digital audio players. No software to install or internet connection required.

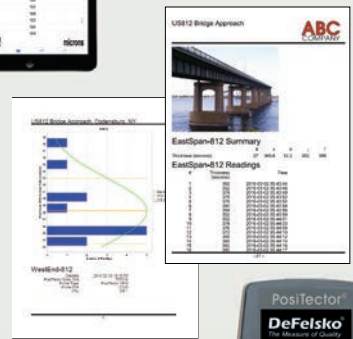

Award Winning Compatibility!

- Coating Thickness
- Surface Profile
- Environmental Conditions
- Shore Hardness
- Salt Contamination
- Ultrasonic Wall Thickness



Duplex Probe measures individual layer thicknesses of zinc and paint in a duplex coating system



Xtreme Probes with Alumina wear faces and braided cables for hot/rough surfaces



Thick Probes series for thick protective coatings: epoxy, rubber, fireproofing and more



Microprobe series for small parts and hard-to-reach areas

		Our most popular Integral and Cabled probe models				90° Regular probe for tight spots	Ideal for duplex coating systems	Ideal for hot and rugged applications	Ideal for anodized aluminum	Microprobes – Our smallest probes for small parts or hard-to-reach areas				Integral and Cabled probes for thick protective coatings; epoxy, rubber, intumescent fireproofing and more					
FERROUS	Standard	F1	FS1	FRS1		FXS1 ¹		FOS1	F45S1	F90S1	F90ES1	FT1	FTS1	FTRS1	FHXS1 ^{1,2}	FKS1	FJS1	FLS1	
	Advanced	F3	FS3	FRS3		FXS3 ¹		FOS3	F45S3	F90S3	F90ES3	FT3	FTS3	FTRS3	FHXS3 ^{1,2}	FKS3	FJS3	FLS3	
NON-FERROUS	Standard	N1	NS1	NRS1				NAS1	N0S1	N45S1	N90S1				NKS1				
	Advanced	N3	NS3	NRS3				NAS3	N0S3	N45S3	N90S3				NKS3				
COMBINATION	Standard	FN1	FNS1	FNRS1	FNDS1 ³								FNTS1					FNGS1 ⁴	
	Advanced	FN3	FNS3	FNRS3	FNDS3 ³								FNTS3					FNGS3 ⁴	
Range		0–60 mils 0–1500 µm			0–80 mils 0–2000 µm	Ferrous: 0–45 mils and 0–1150 µm Non-Ferrous: 0–25 mils and 0–625 µm				0–250 mils 0–6 mm		0–400 mils 0–10,000 µm	0–500 mils 0–13 mm	0–1.0 in. 0–25 mm	0–1.5 in. 0–38 mm	0–2.5 in. 0–63.5 mm			
Accuracy⁵		±(0.05 mil + 1%) 0–2 mils ±(0.1 mil + 1%) >2 mils				±(0.02 mil + 1%) 0–4 mils ±(0.1 mil + 3%) >4 mils				±(0.5 mil + 1%) 0–100 mils ±(0.5 mil + 3%) >100 mils		±(0.1 mil + 3%)	±(1 mil + 3%)	±(0.01 in. + 3%)					
Matching Defelsko Calibration Standards		STDS1 STDA1			STDS4	STDS2 STDA2				STDP1		STDP7	STDP5	STDP2	STDP8				

Ferrous probes measure non-magnetic coatings on ferrous metals. **Non-Ferrous probes** measure non-conductive coatings on non-ferrous metals. 1) **FXS/FHXS Xtreme probe series** with Alumina wear face and braided cable — ideal for rough or hot surfaces up to 250° C (500° F). 2) **FHXS probe** measures non-conductive coatings on steel only. 3) See website for full **FNDS probe** accuracy information. 4) **FNGS probe** measures non-conductive coatings on all metals. 5) Accuracies are stated as a fixed value plus a percentage of the gage's actual reading.

Probe Details (All probe details can be found online at www.defelsko.com/p6000/probes)

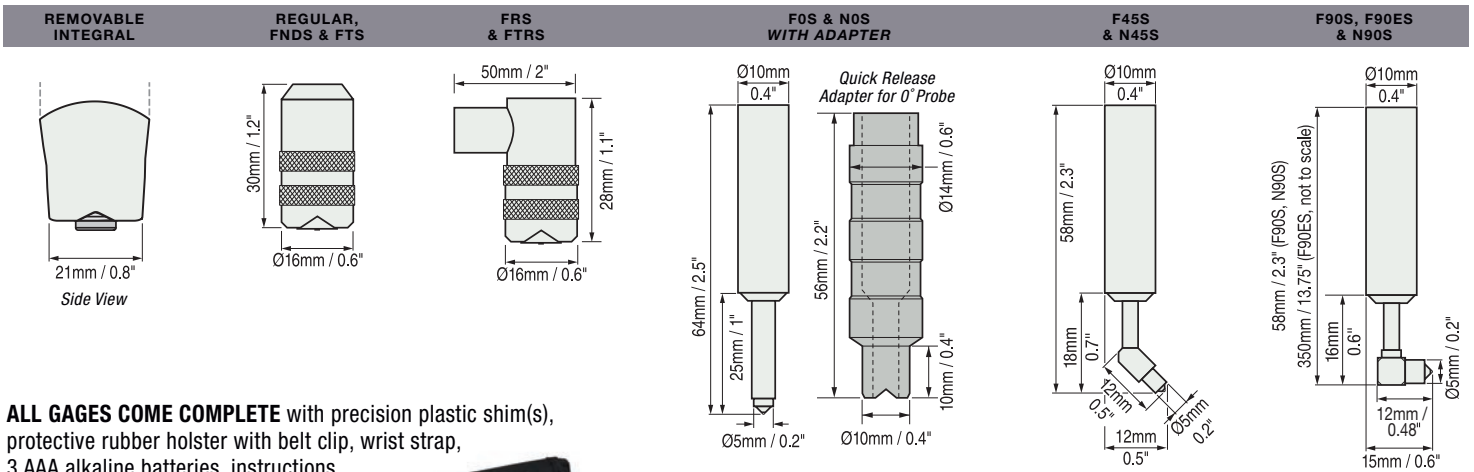

ALL GAGES COME COMPLETE with precision plastic shim(s), protective rubber holster with belt clip, wrist strap, 3 AAA alkaline batteries, instructions, protective lens shield, convenient carrying case, Long Form Certificate of Calibration traceable to NIST or PTB, USB cable, PosiSoft Software, two (2) year warranty.

SIZE: 137 x 61 x 28 mm
(5.4" x 2.4" x 1.1")

WEIGHT: 140 g (4.9 oz.)
without batteries

Conforms to ISO 2178/2360/2808,
ISO 19840, ASTM B244/B499/D1186/
D1400/D7091/E376/G12, BS3900-C5,
SSPC-PA2 and others

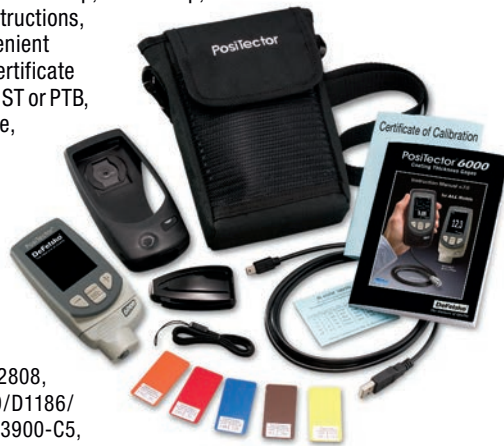

Options

Coating Thickness Standards
to fulfill both ISO and in-house
quality control requirements

Probe Foot Rings
Durable Delrin ring allows the
probe to slide easily while scanning

Telescopic Probe Extender for use
with the PosiTector 6000 FS, NS, FNS,
FXS, FNDS, NAS and FTS probes.

- Provides up to 124 cm (49") of reach and collapses to 47 cm (18.5") for easy storage

For a complete list of product features and available options visit www.defelsko.com



PosiSoft® Suite of Software

Four FREE and unique ways to view and report your PosiTector and PosiTest data

PosiSoft Desktop — PC/Mac

Powerful desktop software for downloading, viewing, printing and archiving measurement data. No internet connection required.

- Import readings directly from the gage via USB or from legacy PosiSoft desktop versions
- Synchronize measurement data including readings, notes and pictures to and from PosiSoft.net
- Import/Export Templates and Jobs to share with other users
- Import PDF forms and overlay **Custom Fields** for automatic population of inspection and measurement data
- Report preview automatically refreshes as changes are made

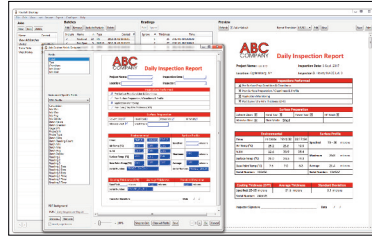

Prompted Batch Mode

Create pre-defined batches with onscreen text and image prompts for each reading and upload to PosiTector 6000 gages (Advanced models only).

- Ideal for ensuring a consistent measurement pattern for repetitive jobs or when specific measurement locations are required
- Create and store multiple templates for different jobs



PosiTector App — Mobile

Mobile app connects PosiTector Advanced instruments, the PosiTector SmartLink and the PosiTest AT-A to your iOS or Android smart device.

- Auto pairing Bluetooth BLE connection
- Automatically generate user-formatted reports and share via email, text, cloud storage services like Dropbox, and more
- Export readings to PosiSoft Desktop or synchronize readings to and from PosiSoft.net for further reporting and archival options



PosiSoft Custom PDF Report Generator

Easily create reports from your measurement data in seconds.

featured on
PosiSoft Desktop
PosiSoft.net
PosiTector App

- Include inspection information such as on-site pictures, screen captures, notes and more to communicate important details
- Create and save multiple custom layouts as templates – insert cover pages, add logos/images, and select font and point size
- Select the information to include for each product type – charts, histograms, readings, time stamps and more
- Compile multi-batch reports from one or more probes and instrument types
- Export readings as comma separated value (.CSV) files which can easily be imported into Excel and other supporting applications

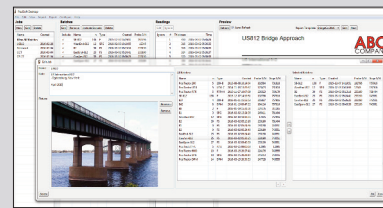
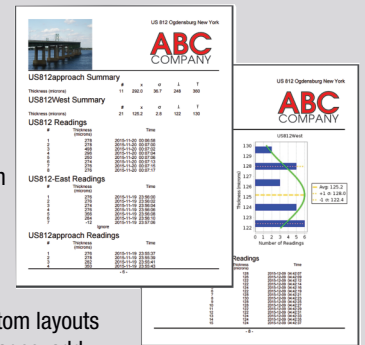

Jobs feature consolidates batches into groups to keep measurement data organized and to quickly create multi-batch reports (not available on PosiTector App)

PosiSoft.net — Web-based

A web-based application offering secure centralized management of readings. Access your data from any web-connected device.

- Synchronize data when connected via USB or WiFi
- Synchronize measurement data including readings, notes and pictures with PosiSoft Desktop and PosiTector App
- Securely store measurement data in the cloud and share with authorized users via a secure login

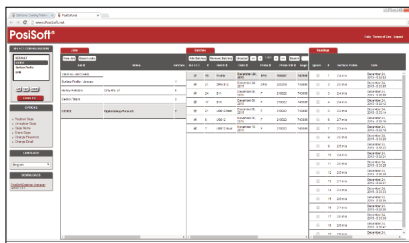

Jobs Batches Readings

PosiSoft USB Drive — Gage Based

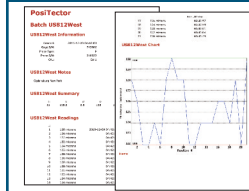

A simple gage interface to retrieve data in a manner similar to USB flash drives, cameras, or digital audio players. No software to install or internet connection required.

- View and print readings and graphs using universal PC/Mac web browsers and file explorers
- Measurement data can be printed quickly from a formatted HTML report or exported in .CSV format for further analysis in spreadsheets
- Simple file management - Copy and paste measurement data from the PosiTector to a local folder on your computer, network folder or cloud drive
- Access stored screen captures (snapshots) of the PosiTector display



PosiTector and PosiTest AT-A instruments can integrate with third-party software, drones, ROVs, PLCs, and robotic devices using several industry-standard communication protocols.

PosiTector Developer Resources

including Bluetooth 4.0, WiFi, USB Keyboard, and USB Serial

DeFelsko®
The Measure of Quality

A2B-LAB
Tel: +212 05 31 06 82 45

Web: www.a2b-lab.ma
Email: contact@a2b-lab.ma

